



**SP AIR CORPORATION**  
*PNEUMATIC TOOLS*  
*FOR PROFESSIONALS*  
**2019 CATALOG**



**MADE IN JAPAN**

# Contents

	Model	Page
SP-1764HD	1/4" Mini Impact Ratchet Wrench	2
SP-1765HD	3/8" Mini Impact Ratchet Wrench	2
SP-7260RP	1/4" The Perfect Impact Ratchet	3
SP-7265RP	3/8" The Perfect Impact Ratchet	3
SP-7730	3/8" Reaction Free High Speed Impact Ratchet	4
SP-7260	1/4" Sealed Flat Head Mini Ratchet	5
SP-7265	3/8" Sealed Flat Head Mini Ratchet	5
SP-7265W	3/8" Wobble Anvil Sealed Flat Head Mini Ratchet	5
SP-7770	1/4" Rotational Head Ratchet Wrench	6
SP-7772	3/8" Rotational Head Ratchet Wrench	6
SP-7786	3/8" Heavy-Duty Sealed Flat Head Ratchet Wrench	7
SP-7787	1/2" Heavy-Duty Sealed Flat Head Ratchet Wrench	7
SP-7780	3/8" Heavy-Duty Sealed Flat Head Ratchet Wrench [Short Version]	8
SP-7144	1/2" Composite Impact Wrench	9
SP-1140EX	1/2" Heavy-Duty Impact Wrench	10
SP-1140EXL	1/2" Heavy-Duty Impact Wrench [2"Extend Anvil]	10
SP-7146EX	1/2" Composite Mini Impact Wrench	11
SP-7146EXS	3/8" Composite Mini Impact Wrench	11
SP-7825	3/8" Composite Mini Impact Wrench	12
SP-7825S	1/4" Composite Mini Impact Wrench	12
SP-1850	3/8" Palm Impact Wrench	13
SP-1850S	1/4" Palm Impact Wrench	13
SP-7150-V8	3/4" Composite Impact Wrench	14
SP-1158	3/4" Impact Wrench	14
SP-1193GE-6	1" Impact Wrench	15
SP-1194DX-6	1" Impact Wrench	15
SP-7610	Recipro Saw [Gear Type]	16
SP-7231	3" Flex Head Cut-Off Tool	17
SP-7231R	3" Reversible Flex Head Cut-Off Tool	18
SP-7220	1/4" Heavy-Duty Straight Die Grinder	19
SP-7211	1/4" Heavy-Duty 90 degree Angle Head Die Grinder	19
SP-7212	1/4" Heavy-Duty 120 degree Angle Head Die Grinder	19
SP-7230	3" Cut-Off Tool	19
SP-4BS	Carbide Burrs 4pc Set	20
SP-4NF	Aluminum / Non-Ferrous 4pc Burr Set	20
SP-7252F	Air Mini Beveler	21
SP-1370A	3/8" & 1/2" x 13" Belt Sander	22
SP-1350	4" High Speed Sander	23
SP-7201DA	2" Mini D/A Sander	23
SP-7527	1/2" Composite Air Drill	24
SP-7527KL	1/2" Composite Air Drill [Keyless Chuck]	24
SP-1460	Needle Scaler [Small]	25
SP-1470	Needle Scaler [Large]	25
SP-7825HU	1/4" Hex. Composite Impact Driver	26
SP-7146HX	1/4" Hex. Composite Impact Driver	26
SP-8102BU	1/4" Hex. Impact Driver	26

## Warranty Policy

SP AIR Corporation offers a limited warranty against defects on all products. Basic warranty coverage is as follows:  
Limited Warranty - All Products One (1) Year from Date of Purchase. Warranty Procedure:  
*Defect products within warranty will be replaced or repaired, and are not to be destroyed in the field.*

- Faulty products in Warranty are to be returned to SP AIR Corporation customer service center address below.
- The product will not be warranty protected unless you provide proof of purchase.

### SP AIR USA, Inc.

1571 Westbelt Drive Columbus, OH 43228  
Toll Free : 855-438-5313  
TEL : 614-529-6600 FAX : 614-529-6700  
E-Mail : sales@spairusa.com

# SP-1764HD

1/4" SUPER FAST MINI IMPACT RATCHET

# SP-1765HD

3/8" SUPER FAST MINI IMPACT RATCHET

**SUPER FAST**



**Built-in Power Regulator**

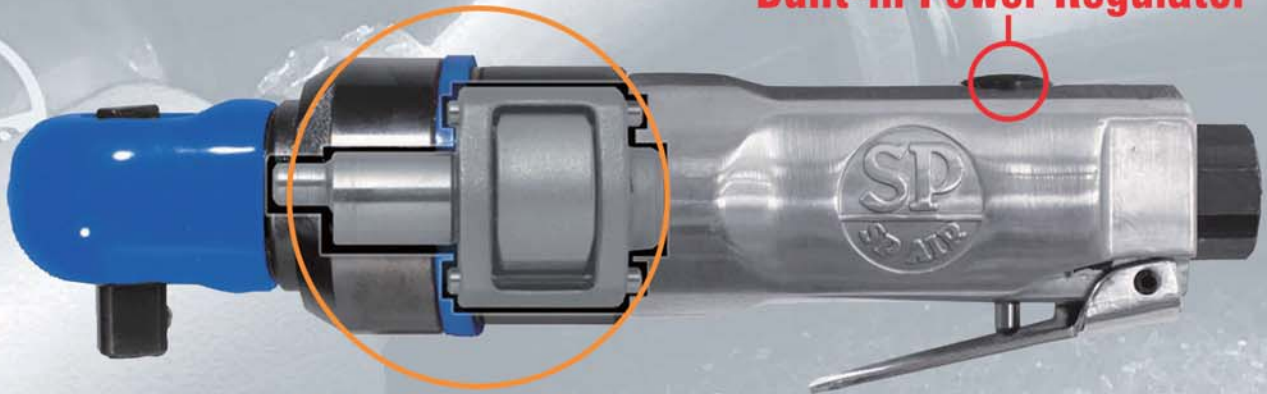

**IMPACT MECHANISM  
[PATENTED]**

**Single Dog Clutch**



For a SP-1765 Demo Video  
visit: [youtube.com/spairtools](https://youtube.com/spairtools)  
or **Scan the QR Code**



**700rpm/55ft-lbs.**

Model No.	Sq. Drive	Bolt Capacity	Max. Torque	Free Speed
SP-1764HD	1/4"	5/16"	55 ft-lbs.	700 rpm
SP-1765HD	3/8"	3/8"	55 ft-lbs.	700 rpm
	Overall Length	Net Weight	Sound Level	
SP-1764HD	6.9"	1.4 lbs.	84.4 dB	
SP-1765HD	6.9"	1.4 lbs.	84.4 dB	

# SP-7260RP

1/4" THE PERFECT IMPACT RATCHET

# SP-7265RP

3/8" THE PERFECT IMPACT RATCHET

## SEALED FLAT RATCHET MECHANISM [PATENTED]

Sealed Flat Head For Long Life



## IMPACT MECHANISM [PATENTED]

Built-in Power Regulator



Single Dog Clutch



**600rpm/45ft-lbs.**

Model No.	Sq. Drive	Bolt Capacity	Max. Torque	Free Speed
SP-7260RP	1/4"	5/16"	45 ft-lbs.	600 rpm
SP-7265RP	3/8"	3/8"	45 ft-lbs.	600 rpm
	Overall Length	Net Weight	Sound Level	
SP-7260RP	7.5"	1.6 lbs.	88.1 dB	
SP-7265RP	7.5"	1.6 lbs.	88.1 dB	

# SP-7730

3/8" REACTION FREE HIGH SPEED IMPACT RATCHET

**HIGH TORQUE**

## SIZE COMPARISON

SP-7730 ▼



SP-1765HD  
3/8" SUPER FAST MINI  
IMPACT RATCHET ▶



**IMPACT MECHANISM  
[PATENTED]**

**Built-in Power Regulator**

**Single Dog Clutch**



**450rpm/100ft-lbs.**

Model No.	Sq. Drive	Bolt Capacity	Max. Torque	Free Speed
SP-7730	3/8"	3/8"	100 ft-lbs.	450 rpm
	Overall Length		Net Weight	Sound Level
SP-7730	11.6"		3.1 lbs.	88.2 dB

# SP-7260

1/4" SEALED FLAT HEAD MINI RATCHET

# SP-7265

3/8" SEALED FLAT HEAD MINI RATCHET

# SP-7265W

3/8" WOBBLE ANVIL SEALED FLAT HEAD MINI RATCHET

## SEALED FLAT HEAD MINI RATCHET

Reverse Lever  
• One-handed operation.

Built-in Air Regulator

360° Exhaust Sleeve



mini

# Light Weight

## (PATENTED) SEALED FLAT RATCHET MECHANISM



## Sealed Flat Head for Long Life



Model No.	Sq. Drive	Bolt Capacity	Max. Torque	Free Speed
SP-7260	1/4"	5/16"	25 ft-lbs.	290 rpm
SP-7265	3/8"	3/8"	25 ft-lbs.	290 rpm
SP-7265W	3/8"	3/8"	25 ft-lbs.	290 rpm
	Overall Length		Net Weight	Sound Level
SP-7260	8"		1.5 lbs.	87 dB
SP-7265	8"		1.5 lbs.	87 dB
SP-7265W	8"		1.5 lbs.	87 dB

# SP-7770

1/4" ROTATIONAL HEAD RATCHET WRENCH

# SP-7772

3/8" ROTATIONAL HEAD RATCHET WRENCH



**To adjust head, slide the ring forward and turn the ratchet housing. <PATENT PENDING>**



Model No.	Sq. Drive	Bolt Capacity	Max. Torque	Free Speed
SP-7770	1/4"	5/16"	25 ft-lbs.	220 rpm
SP-7772	3/8"	3/8"	25 ft-lbs.	220 rpm
	Overall Length	Net Weight	Sound Level	
SP-7770	7.9"	1.3 lbs.	82 dB	
SP-7772	7.9"	1.3 lbs.	82 dB	

# SP-7786

3/8" HEAVY-DUTY SEALED FLAT HEAD RATCHET WRENCH

# SP-7787

1/2" HEAVY-DUTY SEALED FLAT HEAD RATCHET WRENCH

## SEALED FLAT HEAD RATCHET



# High Power

Sealed head design promotes longevity of the tool by preventing ingress of dirt and debris. Shift-on-the-fly directional lever allows one-handed operation.

### [PATENTED] SEALED FLAT RATCHET MECHANISM



### Sealed Flat Head for Long Life

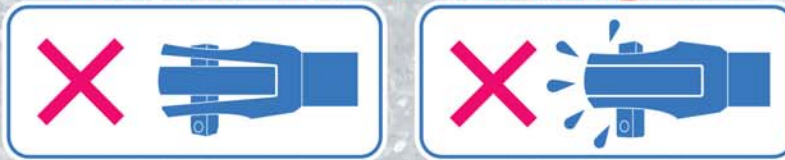

Model No.	Sq. Drive	Bolt Capacity	Max. Torque	Free Speed
SP-7786	3/8"	3/8"	80 ft-lbs.	200 rpm
SP-7787	1/2"	1/2"	80 ft-lbs.	200 rpm
	Overall Length		Net Weight	Sound Level
SP-7786	12"		3.3 lbs.	84.5 dB
SP-7787	12"		3.3 lbs.	84.5 dB

# SP-7780

3/8" HEAVY-DUTY SEALED FLAT HEAD RATCHET WRENCH [SHORT VERSION]

**Reverse Lever**  
• One-handed operation.



## High Power

Sealed head design promotes longevity of the tool by preventing ingress of dirt and debris.  
Shift-on-the-fly directional lever allows one-handed operation.



### (PATENTED) SEALED FLAT RATCHET MECHANISM



### Sealed Flat Head for Long Life

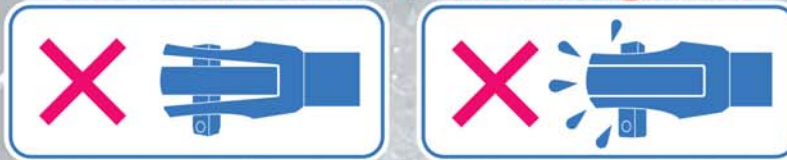

Model No.	Sq. Drive	Bolt Capacity	Max. Torque	Free Speed
SP-7780	3/8"	3/8"	80 ft-lbs.	200 rpm
	Overall Length		Net Weight	Sound Level
SP-7780	9.75"		3.5 lbs.	82.6 dB

# SP-7144 1/2" COMPOSITE IMPACT WRENCH

Composite body greatly reduces weight to allow longer, fatigue free, operation when compared to heavier models with comparable torque and speed specifications.



**Twin Dog Clutch**



**SAS (Side And Side) System**

Forward / Reverse for one hand operation.



**Air Regulator**

4 torque setting and full power reverse.

Model No.	Sq. Drive	Bolt Capacity	Max. Torque	Free Speed
SP-7144	1/2"	5/8"	(F) 750 ft-lbs. (R) 800 ft-lbs.	(F) 5,700 rpm (R) 6,500 rpm
	Overall Length	Net Weight	Sound Level	
SP-7144	6.1"	4 lbs.	93.1 dB	

# SP-1140EX

1/2" HEAVY DUTY IMPACT WRENCH

# SP-1140EXL

1/2" HEAVY DUTY IMPACT WRENCH  
2" EXTEND ANVIL



Reverse Button



Twin Dog Clutch

Ideal choice for heavy automotive and truck work such as tire changing, shock and spring work, farm, body shop, front end work and anywhere else an extra powerful tool is needed.

## Features

Twin dog clutch provides more power and smooth balanced blows.

Produced 800ft.-lbs. of bolt removing torque.

Visual forward regulator with 4 torque settings and one full power reverse setting.

Model No.	Sq. Drive	Bolt Capacity	Max. Torque	Free Speed
SP-1140EX	1/2"	5/8"	800 ft.-lbs.	6,000 rpm
SP-1140EXL	1/2"	5/8"	800 ft.-lbs.	6,000 rpm
	Overall Length		Net Weight	Sound Level
SP-1140EX	7.3"		5.7 lbs.	88.8 dB
SP-1140EXL	8.5"		6.6 lbs.	88.8 dB

# SP-7146EX

1/2" COMPOSITE MINI IMPACT WRENCH

# SP-7146EXS

3/8" COMPOSITE MINI IMPACT WRENCH

## Ultralight



### Compact with superb power



**Twin Dog Clutch**



**SAS (Side And Side) System**

Forward / Reverse for one hand operation.



**Air Regulator**

4 torque setting.

Model No.	Sq. Drive	Bolt Capacity	Max. Torque	Free Speed
SP-7146EX	1/2"	5/8"	440 ft-lbs.	10,000 rpm
SP-7146EXS	3/8"	1/2"	380 ft-lbs.	10,000 rpm
	Overall Length	Net Weight	Sound Level	
SP-7146EX	5.2"	2.1 lbs.	93.1 dB	
SP-7146EXS	5.2"	2.1 lbs.	93.1 dB	

# SP-7825

3/8" COMPOSITE MINI IMPACT WRENCH

# SP-7825S

1/4" COMPOSITE MINI IMPACT WRENCH

## Ultralight



**Double Hammer Clutch**



**SAS (Side And Side) System**

Forward / Reverse for one hand operation.



**Air Regulator**

4 torque setting.

Model No.	Sq. Drive	Bolt Capacity	Max. Torque	Free Speed
SP-7825	3/8"	3/8"	94 ft-lbs.	17,000 rpm
SP-7825S	1/4"	3/8"	94 ft-lbs.	17,000 rpm
	Overall Length		Net Weight	Sound Level
SP-7825	4.3"		1.5 lbs.	84.2 dB
SP-7825S	4.3"		1.5 lbs.	84.2 dB

# SP-1850

3/8" PALM IMPACT WRENCH

# SP-1850S

1/4" PALM IMPACT WRENCH

**ACTUAL SIZE**



**Double Hammer Clutch**



**Air Regulator**  
4 torque setting.



**Palm Size**

Model No.	Sq. Drive	Bolt Capacity	Max. Torque	Free Speed
SP-1850	3/8"	3/8"	72 ft-lbs.	10,000 rpm
SP-1850S	1/4"	3/8"	72 ft-lbs.	10,000 rpm
	Overall Length		Net Weight	Sound Level
SP-1850	5.4"		1.0 lbs.	87.4 dB
SP-1850S	5.4"		1.0 lbs.	87.4 dB

# SP-7150-V8

3/4" COMPOSITE IMPACT WRENCH



**Twin Dog Clutch**



**SAS (Side And Side) System**  
Forward / Reverse for one hand operation.



**Air Regulator**  
Forward, Reverse button with 4 torque setting.



Eight vane motor delivers hard-hitting torque of more than 1,000 ft-lbs while housed in a composite housing weighing less than 8 lbs.

# SP-1158

3/4" IMPACT WRENCH



**Single Dog Clutch**



**Air Regulator**  
Forward, Reverse button with 5 torque setting.



Model No.	Sq. Drive	Bolt Capacity	Max. Torque	Free Speed
SP-7150-V8	3/4"	1"	1,100 ft-lbs.	4,300 rpm
SP-1158	3/4"	1"	1,200 ft-lbs.	5,500 rpm
	Overall Length		Net Weight	Sound Level
SP-7150-V8	9.3"		7.9 lbs.	94.9 dB
SP-1158	8.7"		12.0 lbs.	93.5 dB

# SP-1193GE-6

1" IMPACT WRENCH



**Pinless Hammer Clutch**



**Air Regulator**

Forward, Reverse torque setting.

# SP-1194DX-6

1" IMPACT WRENCH



**Twin Dog Clutch**

Twin dog clutch assembly operates within an oil bath to provide long life and reduced noise.



**Air Regulator**

4 torque setting.



Model No.	Sq. Drive	Bolt Capacity	Max. Torque	Free Speed
SP-1193GE-6	1"	1-1/2"	2,300 ft-lbs.	4,000 rpm
SP-1194DX-6	1"	1-1/2"	1,800 ft-lbs.	4,800 rpm
	Overall Length		Net Weight	Sound Level
SP-1193GE-6	22"		28.7 lbs.	98.0 dB
SP-1194DX-6	20.6"		17.2 lbs.	96.7 dB

# SP-7610 RECIPRO SAW (Gear Type)

- Reciprocating Saw with a gear mechanism is a motor driven saw with a powerful stroke, unlike the piston driven type.
- Cuts Steel, HTSS, FRP, Rubber, Resins and Bumpers etc.



Blade Included	Tool Cutaway
<p style="text-align: center;">SIDE VIEW</p>	<p style="text-align: center;">Gear      Air Motor</p>
(OPTION) 7610-200 Edge Blade	Accessories
<p><b>Set of 10pcs.</b></p> <p style="text-align: center;">Durable 24 TPI blades.</p>	<p style="text-align: center;">Hex. Wrench x1</p> <p style="text-align: center;">Edge Blade x2</p>

Model No.	Stroke Per Minute	Stroke	Overall Length
SP-7610	5,300	0.47"	8.15"
	Net Weight	Sound Level	
SP-7610	1.3 lbs.	86.5 dB	

# SP-7231

FLEX HEAD CUT-OFF TOOL  
Disc Size : 3"



## ▼3-POSITION FLEX HEAD



3-position, flexible head for greater access into tight work places. Ergonomic design cushion-grip handle. Rear exhaust. Safety throttle lever. Built-in power regulator. Direct drive motor. Graduated trigger. Metal guard. Cuts muffler clamps and hangers, sheet metal, radiator hose clamps, bumper bolts, and even steel rods up to 3/4".

Model No.	Disc Size	Free Speed	Overall Length
SP-7231	3"	18,000 rpm	8.6"
	Net Weight	Sound Level	
SP-7231	2.6 lbs.	90.0 dB	

# SP-7231R

REVERSIBLE FLEX HEAD CUT-OFF TOOL  
Disc Size : 3"

## REVERSIBLE

Disc Cover

Built-in Power Regulator

Rear Exhaust



Reverse Lever

Safety Throttle Lever

Reversible Feature throws sparks and debris away from the operator.

### ▼ 3-POSITION FLEX HEAD



3-position, flexible head for greater access into tight work places. Ergonomic design cushion-grip handle. Rear exhaust. Safety throttle lever. Built-in power regulator. Direct drive motor. Graduated trigger. Metal guard. Cuts muffler clamps and hangers, sheet metal, radiator hose clamps, bumper bolts, and even steel rods up to 3/4".

Model No.	Disc Size	Free Speed	Overall Length
SP-7231R	3"	12,000 rpm	8.8"
	Net Weight	Sound Level	
SP-7231R	2.8 lbs.	90.0 dB	

# SP-7220

1/4" HEAVY-DUTY STRAIGHT DIE GRINDER



Ergonomic design cushion-grip handle. Rear exhaust. Built-in power regulator. Safety throttle lever. Direct drive motor with graduated trigger.

# SP-7211

1/4" HEAVY-DUTY 90degree ANGLE HEAD DIE GRINDER



Ergonomic design cushion-grip handle. Rear exhaust. Built-in power regulator. Safety throttle lever.

# SP-7212

1/4" HEAVY-DUTY 120degree ANGLE HEAD DIE GRINDER



120 degree Angle head. Ergonomic design cushion-grip handle. Rear exhaust. Built-in power regulator. Safety throttle lever.

# SP-7230

CUT-OFF TOOL [DISC SIZE : 3"]



Ergonomic design cushion-grip handle. Rear exhaust. Safety throttle lever. Built-in power regulator. Direct drive motor. Graduated trigger. Metal guard. Cuts muffler clamps and hangers, sheet metal, radiator hose clamps, bumper bolts, and even steel rods up to 3/4".

Model No.	Collet Size	Disc Size	Free Speed
SP-7211	1/4"	-	18,000 rpm
SP-7212	1/4"	-	18,000 rpm
SP-7220	1/4"	-	20,000 rpm
SP-7230	-	3"	20,000 rpm
	Overall Length	Net Weight	Sound Level
SP-7211	6-7/8"	1.75 lbs.	87.8 dB
SP-7212	6-5/8"	1.69 lbs.	86.8 dB
SP-7220	6-7/8"	1.37 lbs.	90.1 dB
SP-7230	6-3/4"	1.50 lbs.	90.0 dB

# SP-4BS

## CARBIDE BURRS 4pc SET

### Feature & Benefit

For use with 1/4" High Speed Die Grinders.  
For use in metalworking, mold and pattern making, die sinking, surface cleaning and maintenance.

Removes Burrs from Sheet metal or cast iron.  
Cleans up welding areas.

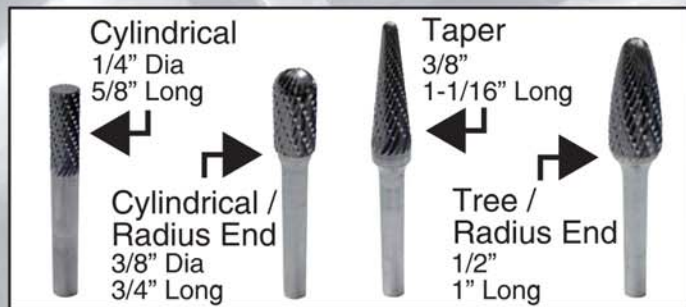

# SP-4NF

## ALUMINUM / NON-FERROUS 4pc BURR SETS

### Feature & Benefit

Allowing rapid stock removal on non-ferrous and  
plastics materials

Avoiding Clogging

Ensures smooth cutting operation

Giving a guaranteed smoother grinding operation



# SP-7252F

## AIR MINI BEVELER



**Safety Throttle Lever**

**PALM SIZE**

**Front Exhaust for cooling metal.**

Use the Palm Beveler to; Clean up welds, Beveling steel or aluminum edges for custom work. Automotive, Motorcycles, Marine and Aircraft uses. 45° Straight and Radius Blade available.

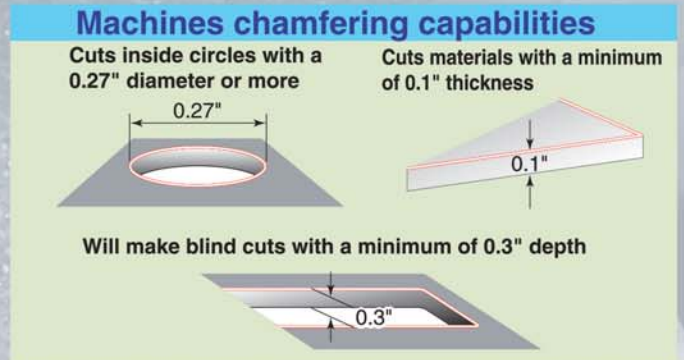
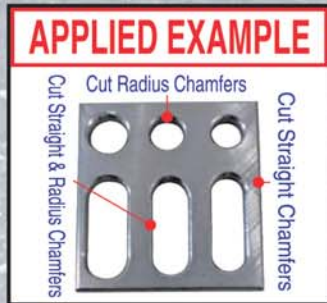

Model No.	Minimum Diameter	Chamfering Capacity	Free Speed
SP-7252F	0.27"	1/16"C	23,000 rpm
	Overall Length	Net Weight	Sound Level
SP-7252F	4-3/8"	0.9 lbs.	81.5 dB

# SP-1370A

3/8" & 1/2" x 13" BELT SANDER

Quick change belt guide allows belt replacement in seconds.

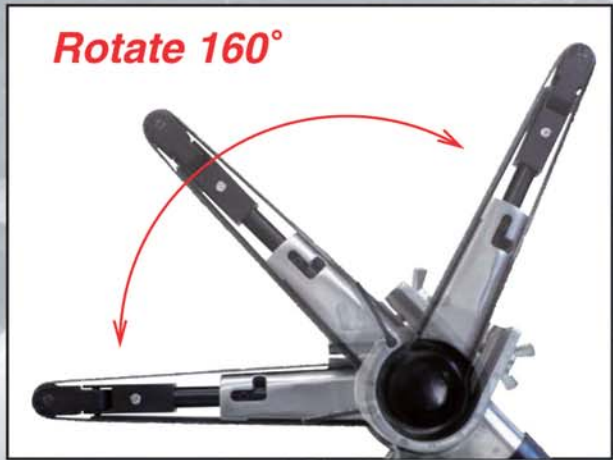

## REPLACEMENT BELT



**370-80-5P** (60 Grid 3/8"x13")  
Replacement Belt 5 Pack  
**370-80-10P** (60 Grid 3/8"x13")  
Replacement Belt 10 Pack

Model No.	Belt Size	Free Speed	Overall Length
SP-1370A	3/8 & 1/2" x 13"	16,000 rpm	11"
	<b>Net Weight</b>	<b>Sound Level</b>	
SP-1370A	1.7 lbs.	82.0 dB	

# SP-1350

4" HIGH SPEED SANDER

**Compact and lightweight.**

Rubber Cover



Handle Exhaust with Silencer

# SP-7201DA

2" MINI D/A SANDER

**Compact and lightweight.**



Swivel Air Inlet with Rear Air Exhaust

## 2" SANDING DISC 180 GRID

-  25 Pack #7201DA-18025P
-  50 Pack #7201DA-18050P
-  100 Pack #7201DA-180100P

## 2" SANDING DISC 320 GRID

-  25 Pack #7201DA-32025P
-  50 Pack #7201DA-32050P
-  100 Pack #7201DA-320100P

Model No.	Paper Size	Disc/Pad Size	Free Speed
SP-1350	4"	3"	15,000 rpm
SP-7201DA	-	2"	12,000 rpm
	Overall Length	Net Weight	Sound Level
SP-1350	5"	2.1 lbs.	77.8 dB
SP-7201DA	6.3"	1.3 lbs.	87.9 dB

# SP-7527

# SP-7527KL

1/2" COMPOSITE AIR DRILL

1/2" COMPOSITE AIR DRILL  
[KEYLESS CHUCK]



1/2" (13mm)  
Drill Chuck

Light Weight  
Composite Body

400rpm

1/2" (13mm)  
Keyless Chuck

Light Weight  
Composite Body

Double Gear Mechanism

**SAS (Side And Side) System**

Forward / Reverse for one hand operation.

Air Exhaust with Muffler



Model No.	Chuck Size	Free Speed	Overall Length
SP-7527	1/2"	400 rpm	7"
SP-7527KL	1/2"	400 rpm	7.1"
	Net Weight	Sound Level	
SP-7527	2.9 lbs.	86.8 dB	
SP-7527KL	2.9 lbs.	86.8 dB	

# SP-1460

NEEDLE SCALER [SMALL]

# SP-1470

NEEDLE SCALER [LARGE]

## SP-1460 ▼



## SP-1470 ▼



Model No.	Piston Dia.	Piston Stroke	Number of Needles	Blows / min.
SP-1460	3/4"	1/2"	12pc	5,000 bpm
SP-1470	1"	7/8"	19pc	4,000 bpm
	Overall Length	Net Weight	Vibration Level:a	Air Consumption
SP-1460	9"	2.8 lbs.	27.87 m/s <sup>2</sup>	0.8 cfm
SP-1470	16"	5.7 lbs.	31.68 m/s <sup>2</sup>	2.0 cfm

# SP-7825HU

1/4" HEX. COMPOSITE IMPACT DRIVER



Double Hammer Clutch



**SAS (Side And Side) System**  
Forward / Reverse for one hand operation.



Air Regulator

**Ultralight**

1/4" Hexagonal

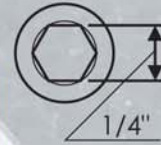

# SP-7146HX

1/4" HEX. COMPOSITE IMPACT DRIVER



Double Hammer Clutch



**SAS (Side And Side) System**  
Forward / Reverse for one hand operation.



Air Regulator

**Ultralight**

1/4" Hexagonal

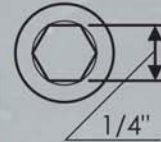

# SP-8102BU

1/4" HEX. IMPACT DRIVER



Double Hammer Clutch



Reverse Lever



Air Regulator

1/4" Hexagonal



Model No.	Hex. Drive	Max. Torque	Free Speed
SP-7825HU	1/4"	94 ft-lbs.	17,000 rpm
SP-7146HX	1/4"	100 ft-lbs.	8,500 rpm
SP-8102BU	1/4"	100 ft-lbs.	11,500 rpm
	Overall Length	Net Weight	Sound Level
SP-7825HU	4.7"	1.5 lbs.	85.5 dB
SP-7146HX	5.3"	2.1 lbs.	92.0 dB
SP-8102BU	6"	2.6 lbs.	90.0 dB

**Manufacturer:**



**SP AIR CORPORATION**

*Tokyo, Japan*

***<http://www.spair.co.jp/>***

**USA Office:**

***SP AIR USA, Inc.***

***<http://www.spairusa.com/>***

1571 Westbelt Drive Columbus, OH 43228-3829

Toll Free:855-438-5313

TEL:614-529-6600 FAX:614-529-6700

E-Mail:sales@spairusa.com

**DISTRIBUTED BY:**